



Form

Attachment inquiry / order Tripping Device BF

FB 8.2.2.1 02en

Seite 1 von 1

INQUIRY

ORDER

Sautter Lift Components
GmbH

Email: sales@slc-liftco.com

Order no.:

Customer:

Cust. Order no.:

Contact person:

Site reference:

Date:

Comm. no.:

Required date:

TRIPPING DEVICE for safety gear type BF

Distance between middle of guide rail and OSG rope >240 and <390

BF Standard and Tandem

Side-mounted with connection to OSG rope 5-6.5 mm 106.700.400
6-8.0 mm 106.700.390

Side-mounted without connection to OSG rope 106 700 392

BF Triple

Mounting with connection to rope 5-6,5 mm 106.700.402
6-8 mm 106.700.396

Mounting w/o connection to rope 106.700.397

Distance between guide rail and OSG rope <240 or >390mm

Zusätzlich zu Zugrohr 1,0 m VE Zub. Zugrohr, Seil 6,5
Auslösegestänge: Zugrohr 3,0 m VE Zub. Zugrohr, Seil 8,0

Position of OSG (please check)

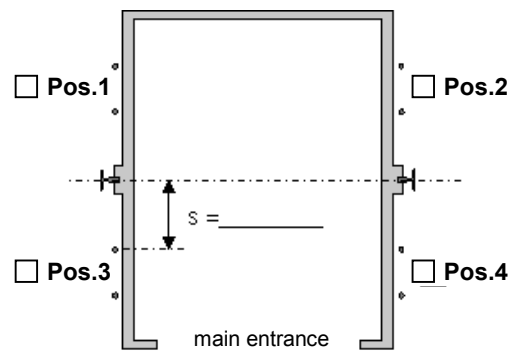

S = Distance between middle of guide rail and OSG rope

BF Standard

side-mounted, above

side-mounted, below

BF under car

(Mounting on top of car also possible)

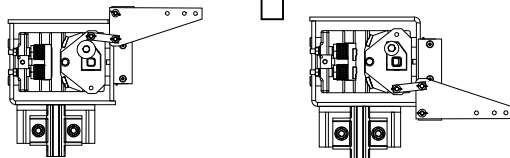

Tripping device with pull tube

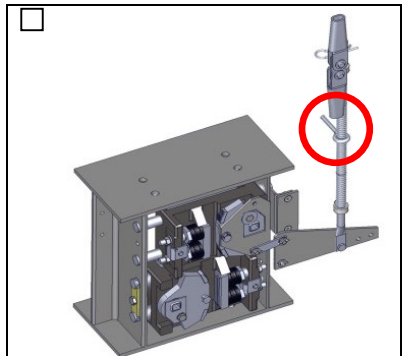

Sample:

BF Tandem with tripping device 'side-mounted' and 'pull tube 1,000mm' and 'PU accessory pull tube'
(When mounting, note the central guide through the eyebolt)

BF Tandem

side-mounted, above

side-mounted, below

BF Triple

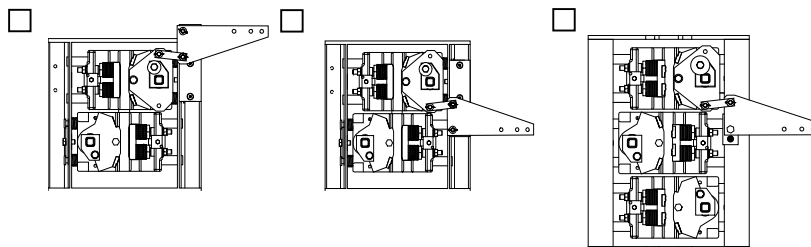

Sketches (as information about the scope of delivery)

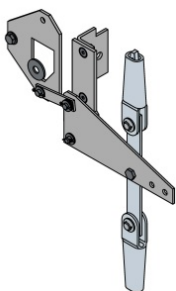

Side-mounted, below with connection to OSG rope

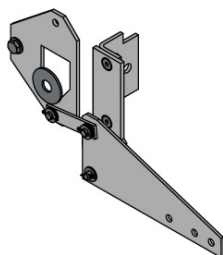

Side-mounted, below w/o connection to OSG rope

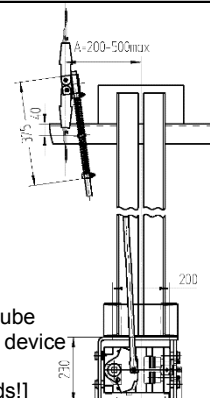

Triggering directly with pull tube on turn-sheave, w/o tripping device (refer FB 8.2.2.1 01), [Only suitable for acting downwards!]